

PHP-3500-HV User's Manual

0. Safety Guidelines	1
1. Introduction	1
1.1 Introduction	1
1.2 Features	1
1.3 Order Information	1
1.4 Main Specification	2
2. Mechanical Specification and Input/Output Terminals	3
2.1 Mechanism	3
3. Functions	4
3.1 Input Voltage Range	4
3.2 Inrush Current Limiting	4
3.3 Rated Power	4
3.4 Power Factor Correction (PFC)	4
3.5 Output Voltage/Current Adjustment	5
3.6 Short-Circuit and Over-Current Protection	6
3.7 Over-Voltage Protection	6
3.8 Over-Temperature Protection and Alarm	6
3.9 DC OK Signal	6
3.10 Remote Control	6
3.11 Auxiliary Power	6
3.12 Factory Resetting	6
4. Communication contract	7
4.1 PMBus Communication Interface	7
4.2 CANBus Communication Interface	13
5. Notes on Operation	19
5.1 Derating	19
5.2 Water Cooling System	19
5.3 Warranty	20



PHP- 3500-HV User's Manual

0.Safety Guidelines

- ⊙ Risk of electrical shock and hazard, all failure should be examined by a qualified technician. Please do not remove the case from the supply by yourself.
- ⊙ Please do not change any component on the unit or make any kind of modification on it.
- ⊙ Please do not install the unit in places with high ambient temperature or under direct sunlight.
- ⊙ The input voltage range is 100-240Vac(50/60Hz), please do not feed in voltage that is over or less than 10% of that range.

1.Introduction

1.1 Introduction

PHP series is a water-cooled power supply designed to provide energy for industrial control systems, battery charging systems and laser processing equipment.

1.2 Feature Description

- ⊙ Universal AC input/Full range.
- ⊙ Built-in active PFC function, PF>0.95.
- ⊙ Protection: Short circuit/ Overload/ Over voltage/ Over temperature.
- ⊙ Built-in remote ON-OFF control and DC-OK active signal.
- ⊙ Output voltage programming.
- ⊙ Output current programming.
- ⊙ 12V/0.5A auxiliary output.
- ⊙ PMBus serial data transmission function.
- ⊙ 5 years warranty.

1.3 Order Information

1.3.1 Explanation for Encoding



1.3.2 Marking

- ⊙ Please refer to the safety label sticker on the top of the unit before use (Figure 1-1).

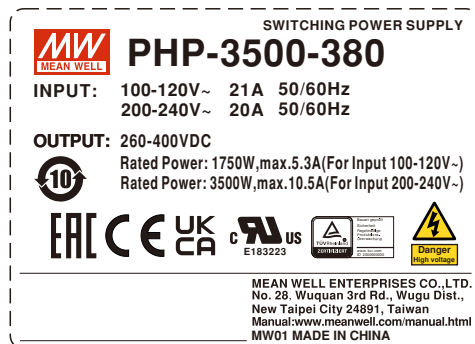
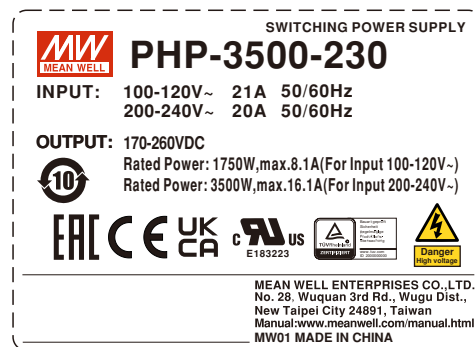
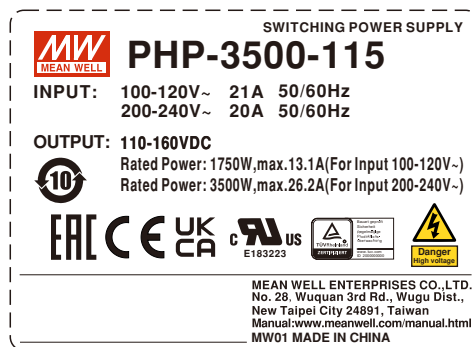

Figure 1-1 PHP-3500 Safety label sticker

1.4 Main Specification

MODEL	PHP-3500-115	PHP-3500-230	PHP-3500-380	
OUTPUT	DC VOLTAGE (Factory default)	115V	230V	380V
	CURRENT (Factory default)	25.2A	15.2A	9.2A
	RATED CURRENT(Max.)	26.3A	16.1A	10.5A
	POWER (Factory default)	2898W	3500W	3500W
	RATED POWER(Max.) Note.11	3500W	3500W	3500W
	RIPPLE & NOISE (Max.) Note.2	1.15Vp-p	2.3Vp-p	3.8Vp-p
	VOLTAGE ADJ. RANGE	By built-in potentiometer, SVR		
		110~160V	170~260V	260~400V
	VOLTAGE TOLERANCE Note.3	±1.0%	±1.0%	±1.0%
	LINE REGULATION	±0.5%	±0.5%	±0.5%
	LOAD REGULATION	±0.5%	±0.5%	±0.5%
SETUP, RISE TIME	2000ms, 60ms/230VAC at full load 2500ms, 60ms/115VAC at 60% load			
HOLD UP TIME (Typ.)	16ms/230VAC at 75% load 10ms/230VAC at full load 10ms/115VAC at 60% load			
INPUT	VOLTAGE RANGE Note.4	90 ~ 264VAC 127 ~ 370VDC		
	FREQUENCY RANGE	47 ~ 63Hz		
	POWER FACTOR (Typ.)	PF ≥ 0.95/230VAC at full load PF ≥ 0.95/115VAC at 60% load		
	EFFICIENCY (Peak) Note 10	95%	95.5%	96%
	AC CURRENT (Typ.)	20A/230VAC 21A/115VAC		
	INRUSH CURRENT (Typ.)	Cold start 80A/230VAC 40A/115VAC		
	LEAKAGE CURRENT	2mA / 240VAC		
PROTECTION	OVERLOAD	105 ~ 115% rated output power Protection type : Constant current limiting, unit will shut down after 5 sec, re-power on to recover.		
	SHORT CIRCUIT	Protection type : Constant current limiting, unit will shut down after 5 sec, re-power on to recover.		
	OVER VOLTAGE	168 ~ 200V	273 ~ 320V	413 ~ 460V
		Protection type : Shut down O/P voltage, re-power on to recover		
	OVER TEMPERATURE	Protection type : Shut down O/P voltage, recovers automatically after temperature goes down		
FUNCTION	OUTPUT VOLTAGE PROGRAMMABLE(PV) Note 5,6	Adjustment of output voltage is allowable to 50~120% of nominal output voltage. Please refer to the function manual		
	OUTPUT CURRENT PROGRAMMABLE(PC) Note 6	Adjustment of constant current level is allowable to 20 ~ 100% of rated current. Please refer to the Function Manual.		
	REMOTE ON/OFF CONTROL	Power ON : Short circuit Power OFF : Open circuit		
	AUXILIARY POWER	12V@0.5A tolerance±10%, ripple 150mVp-p		
	DC-OK SIGNAL	The TTL signal out, PSU turn on = -0.5 ~ 0.5V ; PSU turn off = 3.5 ~ 5.5V. Please refer to the Function Manual.		
ENVIRONMENT	WORKING TEMP.	-30 ~ +70°C (Refer to "Derating Curve")		
	WORKING HUMIDITY	20 ~ 90% RH non-condensing		
	STORAGE TEMP., HUMIDITY	-40 ~ +85°C, 10 ~ 95% RH non-condensing		
	TEMP. COEFFICIENT	±0.03%/°C (0 ~ 50°C)		
	VIBRATION	10 ~ 500Hz, 2G 10min./1cycle, 60min. each along X, Y, Z axes		
	OVER VOLTAGE CATEGORY	III ; According to EN61558 ; altitude up to 2000 meters.		
	SAFETY STANDARDS	UL62368-1, TUV BS EN/EN62368-1, EAC TP TC 004 approved ; design refers to BS EN/EN61558-1, BS EN/EN60335-1		
SAFETY & EMC (Note.7,8)	WITHSTAND VOLTAGE	I/P-O/P:6KVDC I/P-FG:4KVDC O/P-FG:4KVDC		
	ISOLATION RESISTANCE	I/P-O/P, I/P-FG,O/P-FG:100M Ohms/500VDC/25°C / 70%RH		
	EMC EMISSION	Parameter	Standard	Test Level / Note
		Conducted	EN55032 (CISPR32)	Class A
		Radiated	EN55032 (CISPR32)	Class A
		Harmonic Current	EN61000-3-12	-----
	EMC IMMUNITY	Voltage Flicker	EN61000-3-3	-----
		Parameter	Standard	Test Level / Note
		ESD	EN61000-4-2	Level 3, 8KV air ; Level 2, 4KV contact
		Radiated	EN61000-4-3	Level 3
		EFT / Burst	EN61000-4-4	Level 3
Surge		EN61000-6-2	2KV/Line-Line 4KV/Line-Earth	
Conducted		EN61000-4-6	Level 3	
EMC IMMUNITY	Magnetic Field	EN61000-4-8	Level 4	
	Voltage Dips and Interruptions	EN61000-4-11	>95% dip 0.5 periods, 30% dip 25 periods, >95% interruptions 250 periods	
OTHERS	MTBF	192.1K hrs min. 63.9Khrs MIL-HDBK-217F (25°C)		
	DIMENSION	380*141.4*60mm (L*W*H)		
	PACKING	4.5Kg;4pcs/19Kg/2.46CUFT		
NOTE	<ol style="list-style-type: none"> All parameters NOT specially mentioned are measured at 230VAC input, rated load and 25°C of ambient temperature. Ripple & noise are measured at 20MHz of bandwidth by using a 12" twisted pair-wire terminated with a 0.1uf & 47uf parallel capacitor. Tolerance :includes set up tolerance, line regulation and load regulation. Derating may be needed under low input voltages. Please check the derating curve for more details. Without water or fan cooling to provide adequate heat dissipation, OTP might be triggered if trimming output voltage by PV signal toward upper or lower limits of nominal voltage. Under such condition, enhanced cooling on PSU is highly recommended. In the control priority on Vout and Iout trimming, Please refer to the table on page 9. Need additional EMI filter to meet regulations of EMC conducted and radiated emission. Characteristics of EMI filter please refer to the table, Minimum Insertion Loss. The power supply is considered a component which will be installed into a final equipment. All the EMC tests are been executed by mounting the unit on a 600mm*900mm metal plate with 1mm of thickness. The final equipment must be re-confirmed that it still meets EMC directives. For guidance on how to perform these EMC tests, please refer to "EMI testing of component power supplies." (as available on http://www.meanwell.com) The ambient temperature derating of 3.5°C/1000m with fanless models and of 5°C/1000m with fan models for operating altitude higher than 2000m(6500ft). The efficiency level is measured at output voltage: 133V (115V model)/ 217V (230V model)/ 333V (380V model). Refer to derating curve. <p>※ Product Liability Disclaimer : For detailed information, please refer to https://www.meanwell.com/serviceDisclaimer.aspx</p>			

2.Mechanical Specification and Input/Output Terminals

2.1 Mechanism

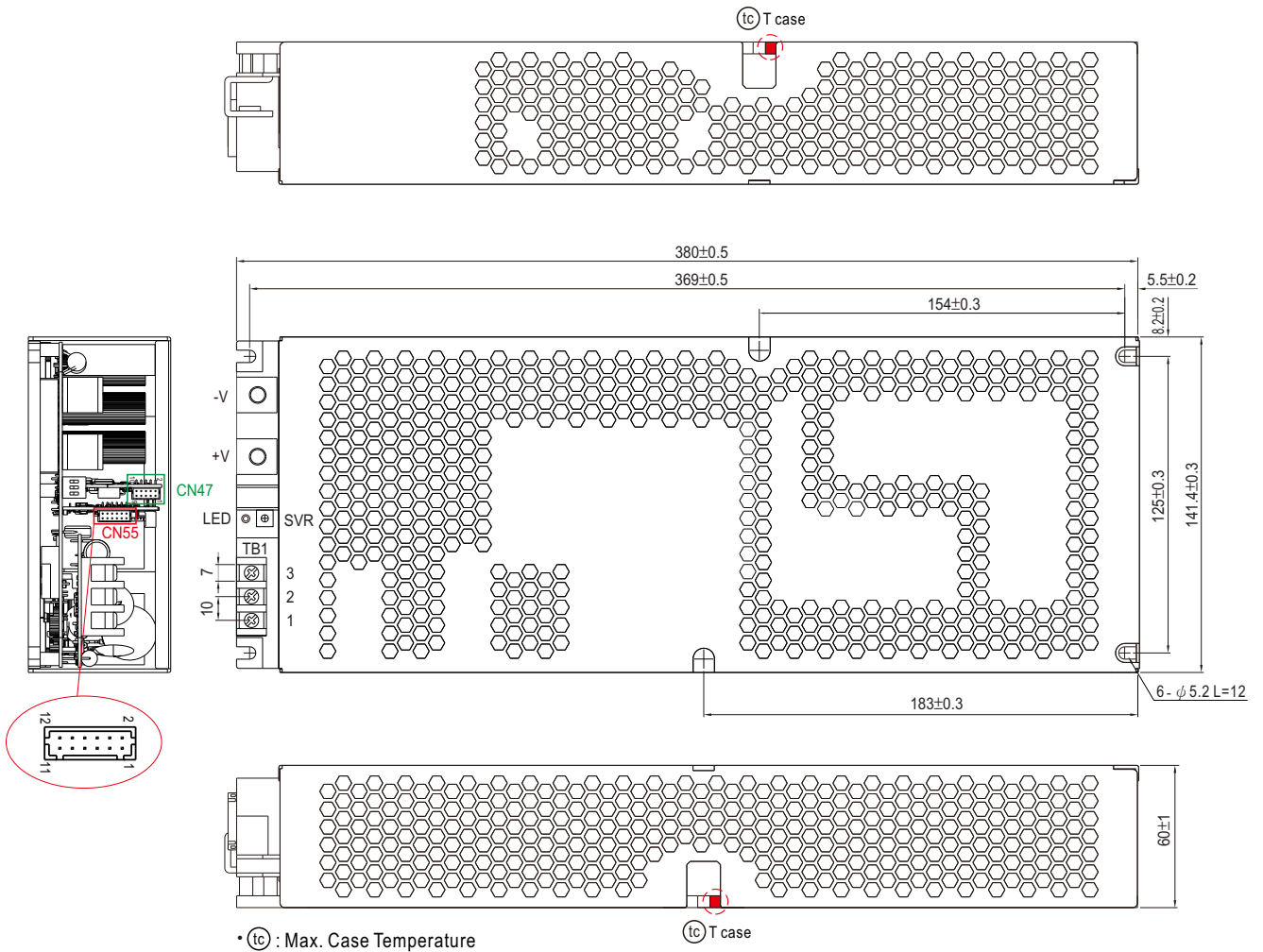

Figure 2-1

AC Input Terminal(TB1) Pin NO. Assignment

Pin No.	Assignment	Terminal	Max mounting torque
1	AC/L	DECA T25-EM10-03	18Kgf-cm
2	AC/N		
3	⊥		

※DC Output Terminal Pin No. Assignment

Assignment	Diagram	Maximum mounting torque
+V, -V		10Kgf-cm

※ LED Status Indicators

LED	Description
	The power supply functions normally
	The LED will flash with red light when internal temperature reaches 85°C; under this condition, the unit still operates normally without entering OTP. (In the meantime, an alarm signal will be sent out through the PMBus /CANBus interface.)
	Abnormal status (Over temperature protection, Overload protection, Fan fail.)

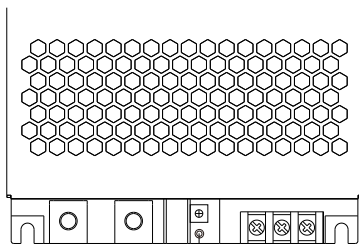

LED Status Indicator

Figure 2-2 PHP-3500 terminal illustration

※Control Pin No. Assignment(CN55) :

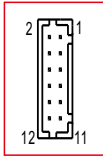

Pin No.	Function	Description
1,3	PV	Connection for output voltage programming. (Note.1)
2,4	PC	Connection for constant current level programming. (Note.1)
5,6	-V (Signal)	Negative output voltage signal.
7,8,9,10,11,12	NC	

Note1: Non-isolated signal, referenced to [-V(signal)].

※Control Pin No. Assignment(CN47) :



Pin No.	Function	Description
1	+12V-AUX	Auxiliary voltage output, 10.8~13.2V, referenced to GND-AUX (pin 2). The maximum load current is 0.5A. This output has the built-in "Oring diodes" and is not controlled by the Remote ON/OFF control.
2	GND-AUX	Auxiliary voltage output GND. The signal return is isolated from the output terminals (+V & -V).
3	Remote ON-OFF	The unit can turn the output ON/OFF by electrical signal or dry contact between Remote ON/OFF and +12V-AUX. (Note.1) Short (10.8 ~ 13.2V) : Power ON ; Open (-0.5 ~ 0.5V) : Power OFF ; The maximum input voltage is 13.2V.
4	GND-AUX(S)	The signal return is isolated from the output terminals (+V & -V).
5	DC-OK	High (3.5 ~ 5.5V) : When the Vout ≤ 80%±5%. Low (-0.5 ~ 0.5V) : When Vout ≥ 80%±5%. The maximum sourcing current is 10mA and only for output. (Note.1)
6	T-ALARM	High (3.5 ~ 5.5V) : When the internal temperature exceeds the limit of temperature alarm. Low (-0.5 ~ 0.5V) : When the internal temperature is normal. The maximum sourcing current is 10mA and only for output(Note.1)
7,8	SDA	For PMBus model: Serial Data used in the PMBus interface. (Note.1)
	CANH	For CANBus model: Data line used in CANBus interface. (Note.1)
9,10	SCL	For PMBus model: Serial Clock used in the PMBus interface. (Note.1)
	CANL	For CANBus model: Data line used in CANBus interface. (Note.1)

Note1: Isolated signal, referenced to GND-AUX(S).

3.Functions

3.1 Input Voltage Range

- ⊙ The input voltage range is AC90~264V or DC127~370V.
- ⊙ To insure proper operation, AC input should be within the pre-specified range. A wrong input will cause the supply unit operating improperly, losing PFC function or even damaging the unit in a worst case scenario.
- ⊙ The efficiency will be lower and the output current will be automatically limited to a predetermined safe value if the unit is applied with a lower input voltage. Please refer to 4.1 Derating for more information.

3.2 Inrush Current Limiting

- ⊙ Built-in inrush current limiting circuit .
- ⊙ If adding an external switch (a relay/ a circuit breaker) at the input side is required, choose switches that are able to withstand inrush current of the unit.
- ⊙ Since the inrush current limiting circuit mainly consists of a NTC thermistor and a relay, inrush current will be much higher than the specified value if the input thermistor is not allowed sufficient time to cool down. After turning off the supply, a 10 second cool down period is recommended before turning them on again.

3.3 Output Power

PHP-3500-115 : 2898W (115V / 25.2A)
 PHP-3500-230 : 3500W (230V / 15.2A)
 PHP-3500-380 : 3500W (380V / 9.2A)

3.4 Power Factor Correction (PFC)

- ⊙ Built-in active power factor correction (PFC) function, power factor (PF) will be 0.95 or better when input voltage is in a range of 90-230Vac and operated at full load condition. PF will be less than 0.95 if the output is not at full load or the input voltage is higher than 230Vac.

3.5 Output Voltage/Current Adjustmen

3.5.1 General adjustment

Output voltage can be trimmed by adjusting SVR (on the terminal end), please utilize an insulated cross-head screwdriver to make an adjustment.

3.5.2 Adjustment with an external 0 - 5Vdc source (Output Voltage Programming)

- (1) Connect output of the external DC source to PV (PIN1 or PIN3) and -V(signal) (PIN5 or PIN6) on CN55, shown in Figure 3-1.
- (2) Relationship between output voltage and external DC source is shown in Figure 3-2.
- (3) While increasing the output to a higher voltage level, please reduce the load current accordingly. Output wattage of the unit should not exceed the rated value under any circumstances.

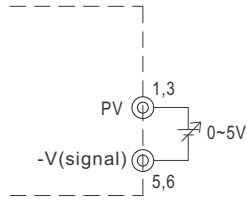
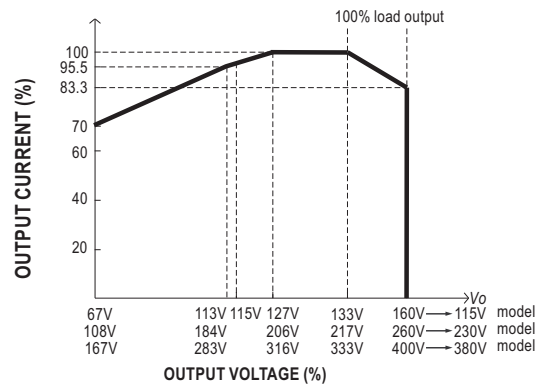
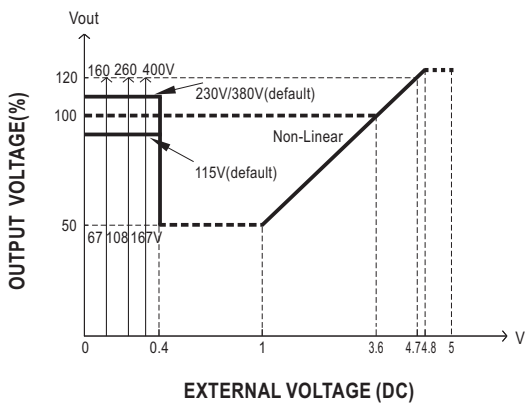

Figure 3-1 Connection of external DC voltage source



⊙ The rated current should change with the output voltage programming accordingly.

Figure 3-2

3.5.3 Output current adjustment (Output Current Programming)

※ Constant current level can be adjusted within a range of 20 -100% of the rated current via an external DC source, wiring is shown as below.

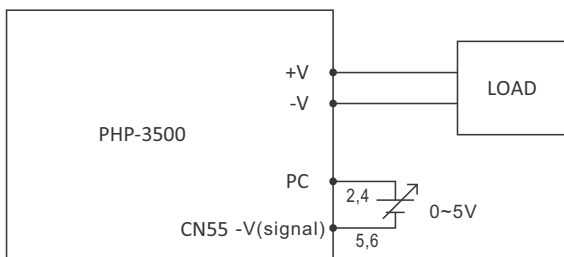

Relationship between output current and external DC source is shown as below.

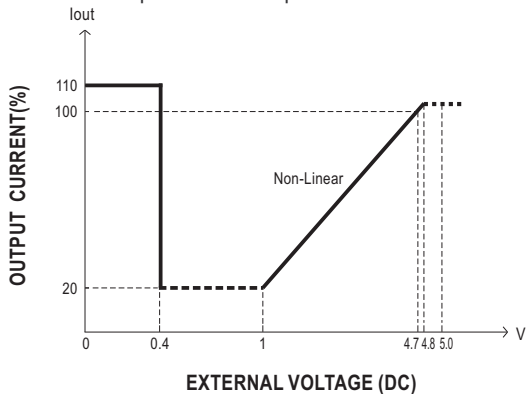

- ⊙ The 100% output current is rated current.
- ⊙ Maximum operation current < 100% is recommended.

Note: The PHP-3500 will trigger OLP to shut down itself if the output stays at constant current level condition for more than 5 seconds.

3.6 Short Circuit Protection & Over Current Protection

- ⊙ The protection activates when the output is short-circuited or the output current exceeds 110%±5 of the rated output current. Re-power on to recover when short-circuit/overload condition is removed.

3.7 Over Voltage Protection (OVP)

- ⊙ Built-in over voltage protection circuit.
- ⊙ OVP triggering points vary in different output models. Please refer to the specification sheet for detailed information.
- ⊙ Once OVP is triggered, leave the unit off for 20 seconds before recycling AC again.

3.8 Over Temperature Protection (OTP) and Alarm

- ⊙ Built-in thermal detection circuit, once the internal temperature exceeds a threshold value, the unit will shut down automatically. Please switch off the AC input, remove all possible causes and then leave the unit cooling down to a normal working temperature (approximate 10 minutes - 1 hour) before repower on again.
- ⊙ When internal temperature reaches 85°C, trigger point of a thermal alarm, the red LED on the output will flash and there will be an alarm signal sent out through the PMBus/CANBus (by request) interface, please refer to 3.12.2. Even so, the unit is still operating normally.
- ⊙ When the internal temperature is within a normal value, there will be a "LOW" signal (-0.5-0.5V) sent out through T-ALARM on CN47; There will be a "HIGH" signal (3.5-5.5V) sent out through T-ALARM on CN47 when internal temperature exceeds a certain value. (referenced to GND-AUX).
- ⊙ Maximum output current: 10mA

3.9 DC OK Signal

- ⊙ Built-in DC output voltage detection circuit.
- ⊙ When DC output voltage is within a normal value, there is a "LOW" signal (-0.5-0.5V) sent out through $\overline{\text{DC-OK}}$ on CN47. (referenced to GND-AUX).
- ⊙ When DC output voltage is out of normal range, there is a "HIGH" signal (3.5-5.5V) sent out through $\overline{\text{DC-OK}}$ on CN47. (referenced to GND-AUX).
- ⊙ Maximum output current: 10mA

3.10 Remote Control

- ⊙ Built-in remote ON/OFF control circuit, refer to Figure 3-3 for the control method.
- ⊙ Please be aware that "ON/OFF" and "+12V-AUX" on CN47 should be linked together to allow the unit operate normally; If they are kept open, there will be no output voltage.
- ⊙ Maximum input voltage: 13.2V

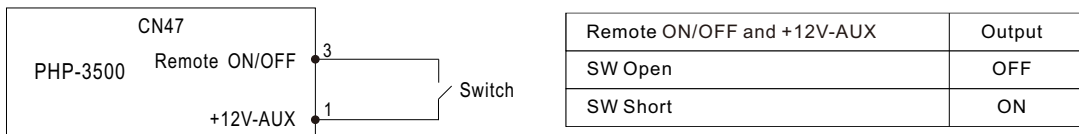

Figure 3-3 Connection of Remote Control

3.11 Auxiliary Output

- ⊙ Built-in 12V/0.5A auxiliary output.

3.12 Factory Resetting

1. PMBus: Users can follow the steps below to restore factory settings for commands: 01h, 22h, 46h and BEh.

- ① Set DIP switch all in the "ON" position.
- ② Turn on the AC without remote on, there should be no voltage at the output.
- ③ Within 15 seconds, set DIP switch all in the "OFF" position and all back in the "ON" again.
- ④ The green LED flashing 3 times means the process is successfully done.
- ⑤ Restart the supply to load factory settings.

2. CANBus: Users can follow the steps below to restore factory settings for commands: 0x0000, 0x0020, 0x0030, 0x00C2.

- ① Set DIP switch all in the "ON" position.
- ② Turn on the AC without remote on, there should be no voltage at the output.
- ③ Within 15 seconds, set DIP switch all in the "OFF" position and all back in the "ON" again.
- ④ The green LED flashing 3 times means the process is successfully done.
- ⑤ Restart the supply to load factory settings.

4. Communication contract

4.1 PMBus Communication Interface

- ⊙ PHP-3500 is compliant with PMBus Rev.1.1, the maximum communication speed is 100KHz and it has the capability of identifying up to 8 addressed units.
- ⊙ PMBus communication interface is able to provide the current operating status and information as followings:
 1. Output voltage, current and internal temperature.
 2. Alarm and status.
 3. Manufacture and model data.

4.1.1 PMBus Addressing

- ⊙ Each PHP-3500 unit should have their unique and own device address to communicate over the PMbus. 7-bit address setting pins are used to assign a device address for a PHP-3500 unit, as shown in the description below.

MSB				LSB		
1	0	0	0	A2	A1	A0

A0- A2 allow users to designate an address for PHP-3500 units; these three bits are defined through a 3-pole DIP switch on the terminal end of the unit. There are up to 8 different addresses are available to be assigned. When DIP switch in the "ON" position means logic "0"; when it is in the "OFF" position, meaning logic "1", for example, position 3 in "OFF", the corresponding bit, A2, is set to logic "1". Please refer to Table 4-1 for the detailed setup advice.



Module No.	Device address		
	A0	A1	A2
	DIP switch position		
	1	2	3
0	ON	ON	ON
1	OFF	ON	ON
2	ON	OFF	ON
3	OFF	OFF	ON

Module No.	Device address		
	A0	A1	A2
	DIP switch position		
	1	2	3
4	ON	ON	OFF
5	OFF	ON	OFF
6	ON	OFF	OFF
7	OFF	OFF	OFF

Table 4-1

4.1.2 PMBus Control Setting

- ⊙ There are two means to control the power supply, analog signals and digital communication. Analog is the default setting for the supply, signals including PV, PC and SVR can be used immediately once receiving the supply. The digital communication of PMBus is initially uncontrollable but readable. To activate the adjustment Commands of OPERATION(01h, regarding remote ON-OFF function), VOUT_TRIM(22h, regarding output voltage programming function) and IOUT_OC_FAULT_LIMIT(46h, regarding output current programming function), set PM_CTRL of SYSTEM_CONFIG(BEh) at "1" and then reboot the supply. Once the digital communication dominates the supply, the analog signals become invalid.

NOTE: 1. At default setting of analog, the following commands are invalid but can be written while other PMBus commands are effective: OPERATION(01h), VOUT_TRIM(22h) and IOUT_OC_FAULT_LIMIT(46h).

2. All written parameters of commands: 01h, 22h and 46h are saved into EEPROM and take effect after the digital is activated.

4.1.3 Initial Operational Behavior Setting

- ⊙ Initial behavior of the power supply can be changed by setting OPERATION_INIT of SYSTEM_CONFIG(BEh), for example: power on without output. For detailed information, please refer to 3.12.5 PMBus Command List.

4.1.4 PMBus Command List

© The command list of the PHP-3500 is shown in Table4-2. It is compliant with the standard protocol of PMBus Rev 1.1. For more detailed information, please refer to PMBus official website(<http://pmbus.org/specs.html>)

Command Code	Command Name	Transaction Type	# of data Bytes	Description
01h	OPERATION	R/W Byte	1	Remote ON/OFF control
02h	ON_OFF_CONFIG	Read Byte	1	ON/OFF function configuration
19h	CAPABILITY	Read Byte	1	Capabilities of a PMBus device
20h	VOUT_MODE	R Byte	1	Define data format for output voltage (format: Linear 16, N= -7)
21h	VOUT_COMMAND	R Word	2	Output voltage setting value (format: Linear 16, N= -7)
22h	VOUT_TRIM	R/W Word	2	Output voltage trimmed value (format: Linear 16, N= -7)
46h	IOUT_OC_FAULT_LIMIT	R/W Word	2	Output overcurrent setting value (format: Linear 11, N= -4)
47h	IOUT_OC_FAULT_RESPONSE	R Byte	1	Define protection and response when an output overcurrent fault occurred
79h	STATUS_WORD	R Word	2	Summary status reporting
7Ah	STATUS_VOUT	R Byte	1	Output voltage status reporting
7Bh	STATUS_IOUT	R Byte	1	Output current status reporting
7Ch	STATUS_INPUT	R Byte	1	AC input voltage status reporting
7Dh	STATUS_TEMPERATURE	R Byte	1	Temperature status reporting
7Eh	STATUS_CML	R Byte	1	Communication, logic, Memory status reporting
80h	STATUS_MFR_SPECIFIC	R Byte	1	Manufacture specific status reporting
88h	READ_VIN	R Word	2	AC input voltage reading value (format: Linear 11, N=-1)
8Bh	READ_VOUT	R Word	2	Output voltage reading value (format: Linear 16, N= -7)
8Ch	READ_IOUT	R Word	2	Output current reading value (format: Linear 11, N= -4)
8Dh	READ_TEMPERATURE_1	R Word	2	Temperature 1 reading value (format: Linear 11, N= -3)
98h	PMBUS_REVISION	R Byte	1	The compliant revision of the PMBus (default: 11h for Rev. 1.1)
99h	MFR_ID	Block Read	12	Manufacturer's name
Command Code	Command Name	Transaction Type	# of data Bytes	Description
9Ah	MFR_MODEL	Block Read	12	Manufacturer's model name
9Bh	MFR_REVISION	Block Read	24	Firmware revision
9Ch	MFR_LOCATION	Block R/W	3	Manufacturer's factory location
9Dh	MFR_DATE	Block R/W	6	Manufacture date. (format: YYMMDD)
9Eh	MFR_SERIAL	Block R/W	12	Product serial number
BEh	SYSTEM_CONFIG	R/W Word	2	System setting
BFh	SYSTEM_STATUS	Read Word	2	System status

Table 4-2

Note :

⊙ Definition of Command BEh SYSTEM_CONFIG

	Bit7	Bit6	Bit5	Bit4	Bit3	Bit2	Bit1	Bit0
High byte	-	-	-	-	-	-	-	-
Low byte	-	-	-	-	-	OPERATION_INIT		PM_CTRL

Low byte

Bit 0 PM_CTRL: PMBus Control Selecting

0=Output voltage and current controlled by SVR/PV/PC(default).

1=Output voltage, current and remote ON/OFF controlled by PMBus (VOUT_TRIM · IOUT_FAULT_LIMIT · OPERATION).

Bit 1: 2 OPERATION_INIT: Initial Operational Behavior

0b00=Power on with 0x00: OFF

0b01=Power on with 0x80: ON (default)

0b10=Power on with the last setting

0b11=Not used

Note: Unsupported settings display with "0"

⊙ Definition of Command BFh SYSTEM_STATUS :

	Bit7	Bit6	Bit5	Bit4	Bit3	Bit2	Bit1	Bit0
High byte	-	-	-	-	-	-	-	-
Low byte	-	EEPROM	INITIAL_STATE	ADL_ON	-	PFC_OK	DC_OK	M/S

Low byte

Bit 0 M/S: Master/Slave Indication

0=The unit is a slave

1=The unit is the master

Bit 1: DC_OK: The DC Output Status

0=DC output too low

1=DC output at a normal range

Bit 2 PFC_OK : The PFC Status

0=The PFC NOT activate or abnormal

1=The PFC activate

Bit 4 ADL_ON : Active Dummy Load Status

0=Active dummy load NOT activate

1=Active dummy load activate

Bit 5 INITIAL_STATE: Initial State Indication

0=The unit NOT in an initial state

1=The unit in an initial state

Note: Unsupported settings display with "0"

Bit 6 EEPER: EEPROM Access Error

0 = EEPROM accessing normally

1 = EEPROM access error

Note:

EEPER: When EEPROM Access Error occurs, the supply stops working and the LED indicator turns red. The supply needs to re-power on to recover after the error condition is removed.

4.1.5 PMBus Data Range and Tolerance

◎ Display parameters

PMBus command		Model	Range	Tolerance
88h	READ_VIN	ALL	80 ~ 264V	±10V
8Bh	READ_VOUT	115V	0 ~ 160V	±1.15V
		230V	0 ~ 260V	±2.3V
		380V	0 ~ 400V	±3.8V
8Ch	READ_IOUT (Note. 1)	115V	0 ~ 32.6A	±1.26A
		230V	0 ~ 28.8A	±0.68A
		380V	0 ~ 11.4A	±0.41A
8Dh	READ_TEMPERATURE_1	ALL	-40 ~ 100°C	±5°C

Table 4-3

◎ Control parameter

PMBus command		Model	Range	Tolerance	Default
01h	OPERATION	ALL	00h(OFF) / 80h(ON)	N/A	80h(ON)
21h	VOUT_COMMAND (Note. 2)	115V	115V	N/A	115V
		230V	230V	N/A	230V
		380V	380V	N/A	380V
22h	VOUT_TRIM (Note. 2)	115V	-48 ~ +45V	±1.15V	0V
		230V	-122 ~ +30V	±2.3V	0V
		380V	-213 ~ +20V	±3.8V	0V
46h	IOUT_OC_FAULT_LIMIT	115V	5.2 ~ 28.93A	±1.18A	28.93A
		230V	3.22 ~ 17.71A	±0.72A	17.71A
		380V	2.1 ~ 11.55A	±0.47A	11.55A
BEh	SYSTEM_CONFIG	ALL	N/A	N/A	02h

Table 4-4

Note:

1. READ_IOUT will display ZERO amp when output current is less than the values in the table below.

Model	Minimum readable current
115V	1.18A±1A
230V	0.72A±1A
380V	0.47A±1A

Table 4-5

2. When using PMBus to adjust output voltage, VOUT_COMMAND only can be used to display the rated voltage of the unit and cannot be written. It is VOUT_TRIM that provides voltage trimming function. Take PHP-3500-115 as an examples, to get a 67V output, please set value of VOUT_TRIM to -48V. Adjustable voltage range for each model is shown as below.

Model	Adjustable voltage range
115V	67 ~ 160V
230V	108 ~ 260V
380V	167 ~ 400V

Table 4-6

3. Insert a at least 35msec delay between commands.

4. Set and read numeric conversion instructions

(1) LINEAR16 format: VOUT_COMMAND, VOUT_TRIM, READ_VOUT.

Actual voltage = Communication reading $V \times 2^N$. The value of N is defined in the VOUT_MODE command.

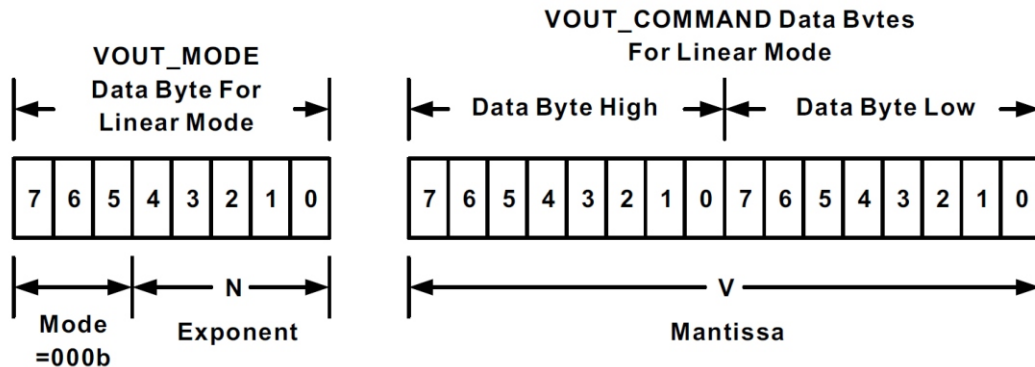

Linear Format Data Bytes

The Mode bits are set to 000b.

The Voltage, in volts, is calculated from the equation:

$$\text{Voltage} = VX2^N$$

Where:

Voltage is the parameter of interest in volts;

V is a 16 bit unsigned binary integer; and

N is a 5 bit two's complement binary integer.

EX: V_{o_real} (actual output voltage) = $VX2^N$. IF VOUT_MODE = 0x17, meaning N is -7.

READ_VOUT is 0xBE00 → 48640, then $V_{o_real} = 48640 \times 2^{-7} = 380V$.

(2) LINEAR11 format: IOUT_OC_FAULT_LIMIT, READ_VIN, READ_IIN, READ_IOUT, READ_TEMPERATURE_1.

Actual value X = communication read value Y x 2^N . Among them, the definition of the description column for each aircraft type is referred to

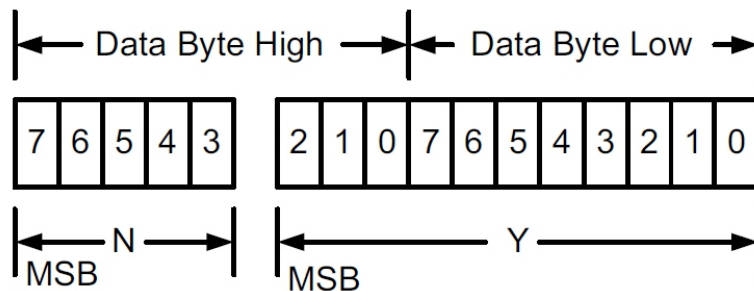

Linear Data Format Data Bytes Y, N and the "real world" value is:

The relation between

$$X = YX2^N$$

Where, as described above:

X is the "real world" value;

Y is an 11 bit, two's complement integer; and

N is a 5 bit, two's complement integer.

Devices that use the Linear format must accept and be able to process any value of N

EX: I_{o_real} (actual output current) = $Y \times 2^N$. IF READ_IOUT is 0xE090h,

meaning N is -4 and Y is 0x0090 → 144, then $I_{o_real} = 144 \times 2^{-4} = 9.0A$.

4.1.6 Practical Operation

The following steps will describe how to set the PHP-3500-380 to 330V.

1. Set the address of the charger to "0". Refer to Table 1-1

2. Connect the SDA, SCL and GND pins of the master to the corresponding SDA (PIN7,8) and SCL (PIN9,10) of CN47 and GND-AUX (PIN2) of CN47 on the supply.

©Set speed: 100KHz



3. Communication function can be accessed immediately after PHP-3500-380 is connected to AC. Set output voltage at 330V.

Address(7 bit)	Operation	Command Code	Data
0x40	Write	0x22	0x00, 0x E7

Command code: 0x22(VOUT_TRIM)
 Data: 330V → 0x00(Lo) + 0xE7(Hi)

4. It is recommended to review all of the settings and parameters using the appropriate commands. In the event that they do not meet your requirements, you may rewrite them as needed. EX: Read VOUT_TRIM to check whether output voltage was set to a proper level.

Read VOUT_TRIM

Address(7 bit)	Operation	Command Code
0X40	Read	0X22

The unit returns data below

Address(7 bit)	Data
0X40	0x00,0xE7

Data: 0x00(Lo) + 0xE7(Hi) → 0xE700 → $-6400 \times 2^{-7} = -50V$ 。
 380V-50V = 330V, the result is correct.

5. Finally, check whether Remote ON-OFF (PIN3) and +12V-AUX (PIN1) pins of the CN47 connector are short-circuited if there is no output voltage. Also please make sure command sending/reading is in an interval of below 4 sec in order not to trigger communication timeout.

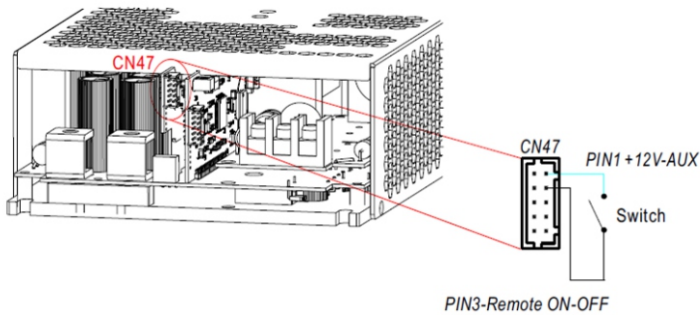

遙控開關	電源狀態
短路 (PIN 1& PIN 3)	開
開路 (PIN 1& PIN 3)	關

4.2 CANBus Communication Interface

4.2.1 CANBus Communication Interface

⊙ Entity layer transport

This protocol adopts CAN ISO-11898 and the Baud rate is 250Kbps.

⊙ Protocol framework format

This protocol uses CAN 2.0B and uses the extended data frame transmission format

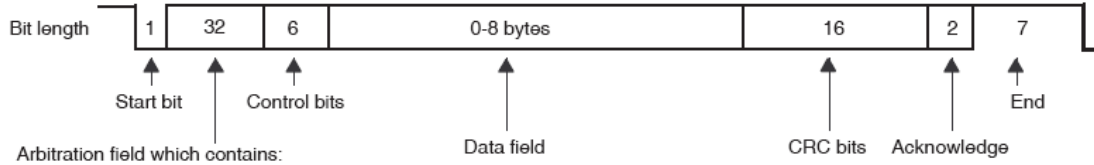

– 29-bit identifier + SRR bit + IDE bit + RTR bit for extended frame format

Where: RTR = Remote Transmission Request

SRR = Substitute Remote Request

IDE = Identifier Extension

⊙ Communication timing

Min. request period (Controller to PHP-3500-HV): 20mSec.

Max. response time (PHP-3500-HV to Controller): 5mSec.

Min. packet margin time (Controller to PHP-3500-HV): 5mSec.

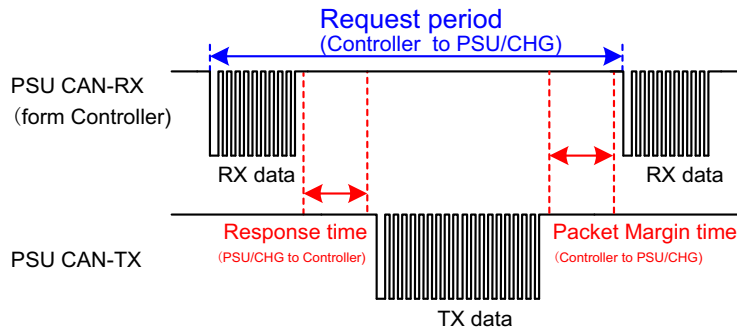

⊙ Data format

Controller to PHP-3500

Write: Data filed bytes

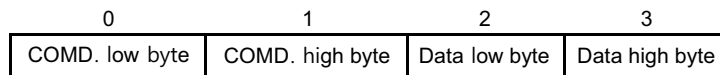

Read: Data filed bytes

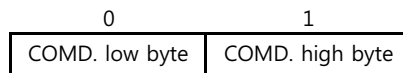

PHP-3500 to controller

Reply: Data filed bytes

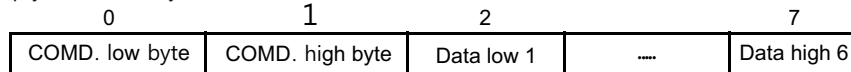

4.2.1.1 PHP-3500 Message ID definition description

Message ID	Narrate
0xC00XX	PHP-3000 to controller Message ID
0xC01XX	Controller for PHP-3000 Message ID
0xC01FF	The controller broadcasts the Message ID to the PHP-3000



Module No.	Device address		
	A0	A1	A2
	DIP switch position		
	1	2	3
0	ON	ON	ON
1	OFF	ON	ON
2	ON	OFF	ON
3	OFF	OFF	ON

Module No.	Device address		
	A0	A1	A2
	DIP switch position		
	1	2	3
4	ON	ON	OFF
5	OFF	ON	OFF
6	ON	OFF	OFF
7	OFF	OFF	OFF

Table 4-1

4.2.1.2 CANBus command list

Command Code	Command Name	Transaction Type	# of data Bytes	Description
0x0000	OPERATION	R/W	1	Turn controls on/off
0x0020	VOUT_SET	R/W	2	Output voltage setting (format: value, F=0.01)
0x0030	IOUT_SET	R/W	2	Export current setting (format: value, F=0.01)
0x0040	FAULT_STATUS	R	2	Abnormal status
0x0050	READ_VIN		2	Input voltage readout (format: value, F=0.01)
0x0060	READ_VOUT	R	2	Output voltage readout (format: value, F=0.01)
0x0061	READ_IOUT	R	2	Output current readout (format: value, F=0.01)
0x0062	READ_TEMPERATURE_1	R	2	Internal ambient temperature reading (format: value, F=0.01)
0x0080	MFR_ID_B0B5	R	6	Manufacturer name
0x0081	MFR_ID_B6B11	R	6	Manufacturer name
0x0082	MFR_MODEL_B0B5	R	6	Manufacturer model name
0x0083	MFR_MODEL_B6B11	R	6	Manufacturer model name
0x0084	MFR_REVISION_B0B5	R	6	Firmware version
0x0085	MFR_LOCATION_B0B2	R/W	3	Place of manufacture
0x0086	MFR_DATE_B0B5	R/W	6	Date of manufacture
0x0087	MFR_SERIAL_B0B5	R/W	6	Manufacturing serial number
0x0088	MFR_SERIAL_B6B11	R/W	6	Manufacturing serial number
0x00C0	SCALING_FACTOR	R	2	Scale factor
0x00C1	SYSTEM_STATUS	R	2	System status
0x00C2	SYSTEM_CONFIG	R/W	2	System settings

4.2.1.3 PHP-3500 CANBus value range and error

(1) Display parameters

CANBus Command		Models	Displays a range of numeric values	Display error
0x0050	READ_VIN	ALL	80~264V	±10V
0x0060	READ_VOUT	115V	0~160V	±1%
		230V	0~260V	±1%
		380V	0~400V	±1%
0x0061	READ_IOUT (Note. I)	115V	0~3.26A	±5%
		230V	0~28.8A	±5%
		380V	0~11.4A	±5%
0x0062	READ_TEMPERATURE_1	ALL	-40~100℃	±5℃

(2) Control parameters

CANBus Command		Models	You can control the range of values	Control errors	Default value
0x0000	OPERATION	ALL	00h(OFF)/01h(ON)	N/A	01h(ON)
0x0020	VOUT_SET	115V	67~160V	±1%	115V
		230V	108~260V	±1%	230V
		380V	167~400V	±1%	380V
0x0030	IOUT_SET	115V	5.26~28.93A	±5%	28.93A
		230V	3.22~17.71A	±5%	17.71A
		380V	2.1~11.55A	±5%	11.55A
0x00C2	SYSTEM_CONFIG	ALL	N/A	N/A	02h

Note:

- i. When the output current is less than the values listed in the table below, the READ_IOUT reading value will be displayed as 0A.

model	Minimum display current
115V	1.18A±1A
230V	0.72A±1A
380V	0.47A±1A

4.2.2 Command support table (information) information definition and content

© FAULT_STATUS(0x0040) the definitions are as follows:

	Bit7	Bit6	Bit5	Bit4	Bit3	Bit2	Bit1	Bit0
Low byte	HI_TEMP	OP_OFF	AC_FAIL	SHORT	OLP	OVP	OTP	FAN_FAIL

Bit 0 FAN_FAIL: Fan abnormal state

0 =The fan is normal

1=The fan is abnormal

Bit 1 OTP : Overtemperature protection state

0 =Not protected against overtemperature

1 =It is protected against over temperature

Bit 2 OVP: Output overvoltage protection status

0 =Not in the output overvoltage protection

1 =Output overvoltage protection

Bit 3 OLP: Overload protection status

0 =Not in overload protection

1 = is under overload protection

Bit 4 SHORT: Short-circuit protection status

0 = Not in short-circuit protection

1 = Protected against short circuits

Bit 5 AC_FAIL: Input voltage abnormal protection status

0 = Non-input voltage anomaly protection

1 = Protection at input voltage abnormality

Bit 6 OP_OFF: Output off indication

0 = is on output

1 = is off at output

Bit 7 HI_TEMP: Warning of excessive ring temperature

0 = at normal ambient temperature

1 = At the ambient temperature is too high

Note: The displayed status is not supported, and the display is 0

© MFR_ID_B0B5 (0x0080) is the first 6 yards of the manufacturer's name; MFR_ID_B6B11 (0x0081) is 6 yards after the manufacturer's name (indicated in ASCII)

EX: THE MANUFACTURER MEANWELL MFR_ID_B0B5 MEANWE; The MFR_ID_B6B11 is LL

MFR_ID_B0B5					
Byte 0	Byte 1	Byte 2	Byte 3	Byte 4	Byte 5
0x4D	0x45	0x41	0x4E	0x57	0x45

MFR_ID_B6B11					
Byte 0	Byte 1	Byte 2	Byte 3	Byte 4	Byte 5
0x4C	0x4C	0x20	0x20	0x20	0x20

© MFR_MODEL_B0B5 is the first 6 yards of the model code; MFR_MODEL_(0x0082) B6B11(0x0083) is the model code after 6 yards (indicated by ASCII)

EX: Model PHP-3500-380 MFR_MODEL_B0B5 is PHP-3500; The MFR_MODEL_B6B11 is 00-380

MFR_MODEL_B0B5					
Byte 0	Byte 1	Byte 2	Byte 3	Byte 4	Byte 5
0x50	0x48	0x50	0x2D	0x33	0x35

MFR_ID_B6B11					
Byte 6	Byte 7	Byte 8	Byte 9	Byte 10	Byte 11
0x30	0x30	0x2D	0x33	0x38	0x30

© MFR_REVISION_B0B5 (0x0084) can represent up to six MCU firmware versions (represented by Binary), where the order is coded by firmware part number in MCU number . The firmware version range of an MCU is 0x00(R00.0)~0xFE(R25.4), and the part without version is indicated by 0xFF.

EX: PSU products have six MCUs, MCU number 1 firmware version is R01.3 version (0x0D), firmware number 2 firmware version R01.2 (0x0C), firmware number 3 firmware version R01.1 (0x0B), and rest R01.0 version (0x0A)

Byte 0	Byte 1	Byte 2	Byte 3	Byte 4	Byte 5
0xFE	0x69	0xFF	0xFF	0xFF	0xFF

© MFR_DATE_B0B5 (0x0086) is defined as the last two codes of AD plus the four codes of the date (expressed in ASCII)

EX: Date of manufacture is January 1, 2018 MFR_DATE_B0B5 180101

Byte 0	Byte 1	Byte 2	Byte 3	Byte 4	Byte 5
0x31	0x38	0x30	0x31	0x30	0x31

© MFR_SERIAL_B0B5 (0x0087), MFR_SERIAL_B6B11 (0x0088) is defined as six codes of the date of manufacture plus six codes of the manufacturing serial number (expressed in ASCII)

EX: Manufactured on January 1, 2018, the first serial number MFR_SERIAL_B0B5 is 180101; MFR_SERIAL_B6B11 is 000001

Byte 0	Byte 1	Byte 2	Byte 3	Byte 4	Byte 5
0x31	0x38	0x30	0x31	0x30	0x31

Byte 6	Byte 7	Byte 8	Byte 9	Byte 10	Byte 11
0x30	0x30	0x30	0x30	0x30	0x31

4.2.3 Communication examples

4.2.3.1 Sending Command

The master adjusts output voltage of the unit with address "01" to 330V .

CAN ID	DLC (data length)	Command code	Parameters
0xC0101	0x4	0x2000	E880

Command code: 0x0020 (VOUT_SET) → 0x20(Lo) + 0x00(Hi)

Parameters: 330V → 33000 → 0x80E8 → 0xE8(Lo) + 0x80(Hi)

NOTE: VOUT_SET conversion factor is 0.01, so $\frac{330V}{F=0.01} = 33000$

4.2.3.2 Read data or status

The master reads the operation settings of the fixed address "00" monomer.

CAN ID	DLC (data length)	Command code
0xC0100	0x2	0x0000

The unit with address "00" returns data below.

CAN ID	DLC (data length)	Command code	Parameters
0xC0000	0x3	0x0000	0x01

Parameters: 0x01 ON, which stands for operation on the "00" unit.

4.2.3.3 Practical Operation

The following steps will describe how to set the PHP-3500-380 to 330V.

1. Set the address of the charger to "0", Refer to Table 4-1.
2. Connect the CANH/CANL pins of the master to the corresponding CANH(PIN7,8) and CANL(PIN9,10) pins of the CN47 connector on the supply. It is recommended to establish a common ground for the communication system to increase its communication reliability by using GND-AUX(PIN2) of CN47.

© Set baud rate: 250kbps, type: extended.

© Adding a 120Ω terminal resistor to both the controller and rack shelf ends can increase communication stability.

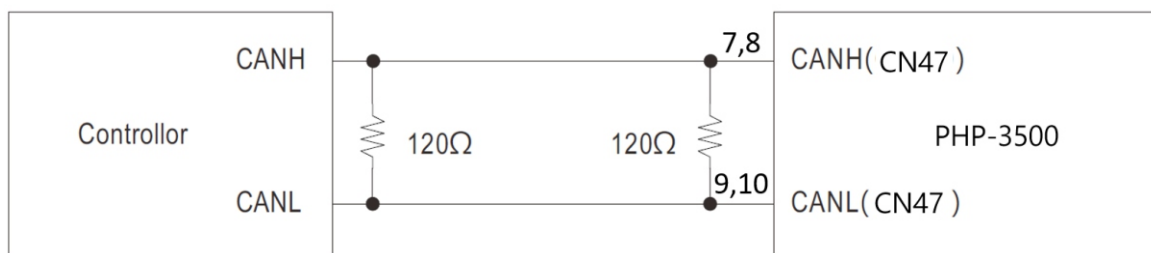

3. Communication function can be accessed immediately after PHP-3500-380 is connected to AC. Set output voltage at 330V.

CAN ID	DLC(data length)	Command Code	Parameters
0XC0100	0X04	0X2000	E880

Command code: 0x0020(VOUT_SET)
 Data: 330V → 33000 → 0x80E8 → 0xE8(Lo) + 0x80(Hi)

NOTE: Conversion factor for VOUT_SET is 0.01, SO $\frac{330V}{F=0.01} = 33000$

4. It is recommended to review all of the settings and parameters using the appropriate commands. In the event that they do not meet your requirements, you may rewrite them as needed. EX: Read VOUT_SET to check whether output voltage was set to a proper level.

Read VOUT_SET

CAN ID	DLC(data length)	Command Code
0XC0100	0X04	0X2000

The unit returns data below

CAN ID	DLC (data length)	Command code	Parameters
0xC0000	0x04	0x2000	E880

Data: 0XE8(Lo) + 0x80(Hi) → 0xE880 → 33000 = 330V。

5. Finally, check whether Remote ON-OFF (PIN3) and +12V-AUX (PIN1) pins of the CN47 connector are short-circuited if there is no output voltage. Also please make sure command sending/reading is in an interval of below 4 sec in order not to trigger communication timeout.

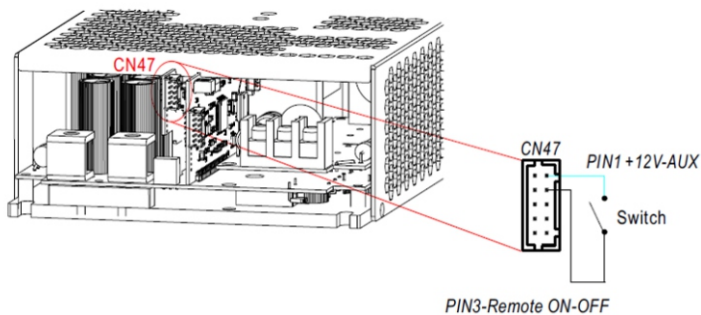

遙控開關	電源狀態
短路 (PIN 1& PIN 3)	開
開路 (PIN 1& PIN 3)	關

5. Note on Operation

5.1 Derating

⊙ When PHP-3500 is operating at a lower AC input voltage, the unit will derate its output current automatically to protect itself.

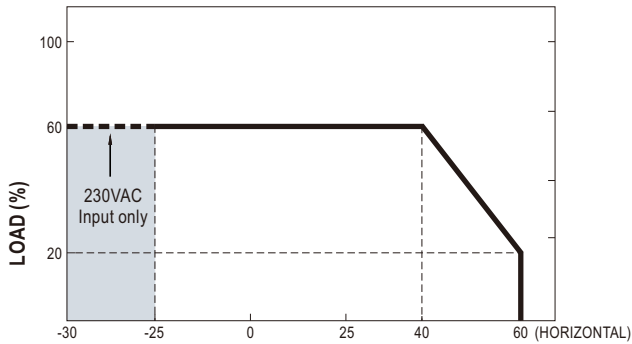

AMBIENT TEMPERATURE WITH ADDITIONAL ALUMINUM PLATE (°C)
(450x450x3mm)

Note. Tcase max. $\leq 70^{\circ}\text{C}$ and ambient temp must be within above de-rating curve.

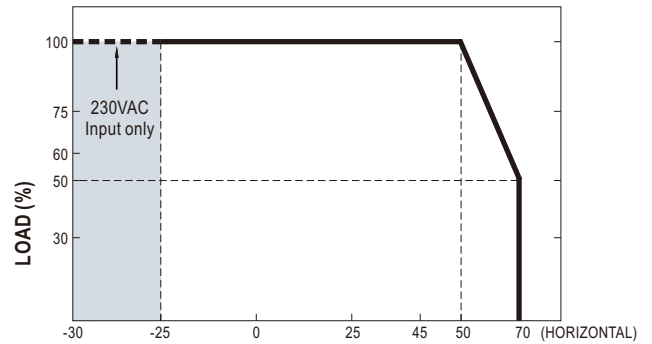

AMBIENT TEMPERATURE WITH 128 CFM FAN*2 OR WATER COOLING SYSTEM (°C)

Note. Tcase max. $\leq 45^{\circ}\text{C}$ and ambient temp must be within above de-rating curve.

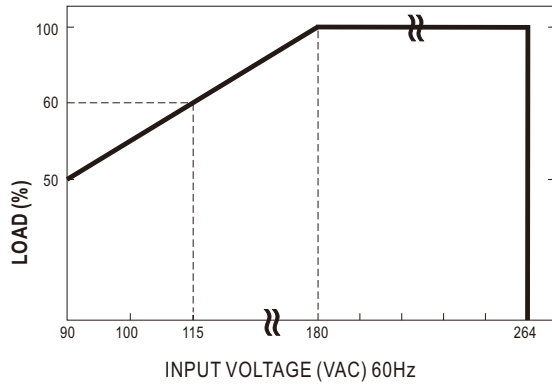

5.2 Water Cooling System

5.2.1 Quality requirement for water cold plate surfaces

⊙ There should be no any shrinkage cavity, corrosion or cracks on the surfaces.

5.2.2 Operational requirement for water cooling loop

- ⊙ Using good quality water is recommended, resistance $< 2.5\text{K}\Omega$ and having a pH of 6-9; Inlet temperature of 25°C , flow rate of 1 liter per minute.
- ⊙ Please make sure there is no fluid leaks, blocks or condensation under operation.

5.2.3 Note on water cold plate design

- ⊙ Material (purity, thickness, machining precision, etc) and manufacturing craft (whether there are cracks, fractures, etc caused by extrusion) have an profound impact on thermal conductivity of a cold plate.
- ⊙ Flatness between mating parts plays a critical role in thermal contact conductance.
- ⊙ Please make sure cooling capacity of the chiller is greater than 175W so as to dissipate heat from the power supply efficiently.

5.2.4 Condensation prevention and control

It is important to minimize or prevent condensation because condensate could drip onto electronics or collect in the bottom of the system and cause corrosion. To avoid condensation, please follow below:

- ⊙ Temperature difference between the water and ambient temperature should be lower than 5°C in hot and humid places.
- ⊙ Turn off the water cooling system during a power outage.

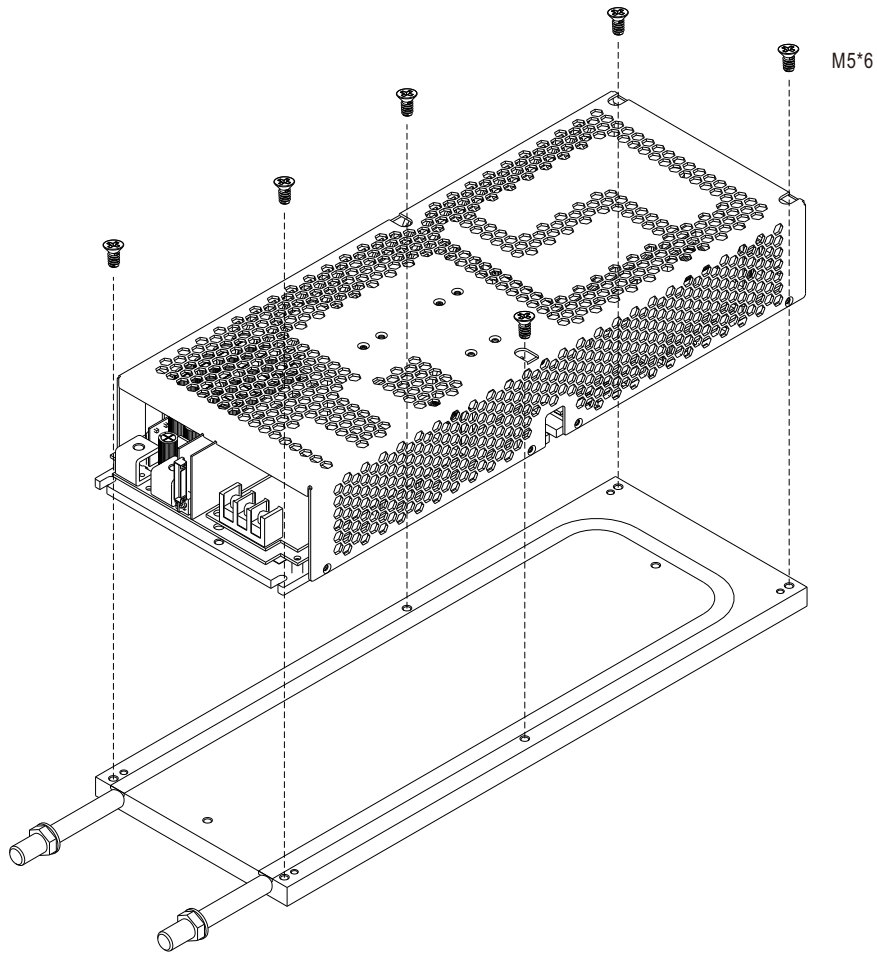

Optional MEAN WELL cold plate is ready for order, Ordering No.: HS-656

5.3 Warranty

© A five year global warranty is provided under normal operation. Please do not change any component or modify the unit by yourself or MEANWELL may reserve the right not to provide the complete warranty service.

明緯企業股份有限公司

MEAN WELL ENTERPRISES CO., LTD.

248 新北市五股區五權三路28號

No.28, Wuquan 3rd Rd., Wugu Dist., New Taipei City 248, Taiwan

Tel: 886-2-2299-6100 Fax: 886-2-2299-6200

<http://www.meanwell.com> E-mail: info@meanwell.com

Your Reliable Power Partner